

OPTIONS

TRANSFORMER

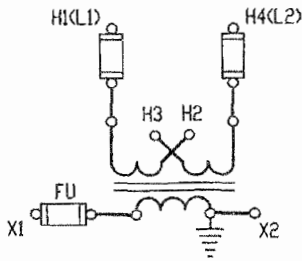

PILOT LIGHTS

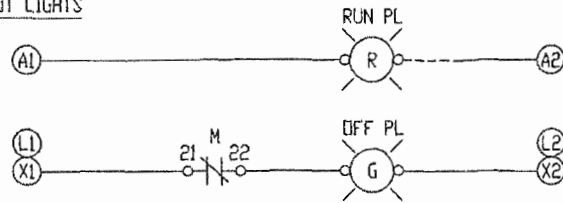

Note: On B05 Overload 95 and 96 terminals are reversed on connection

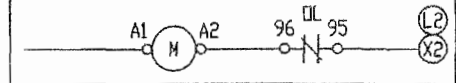

CONTROL CIRCUIT

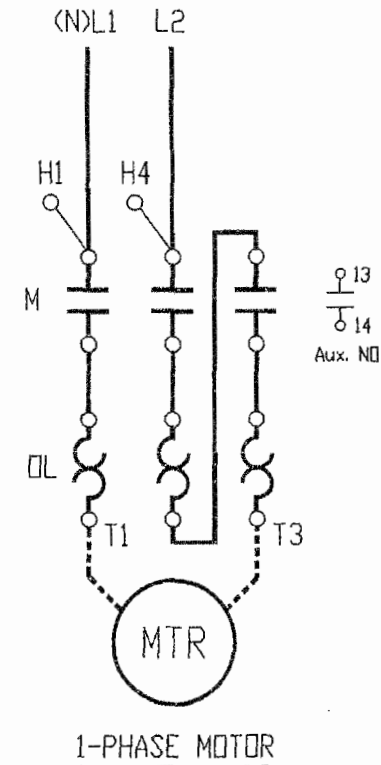
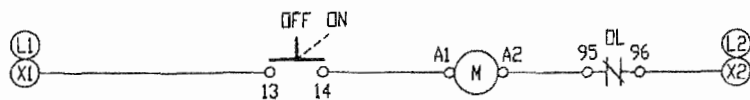
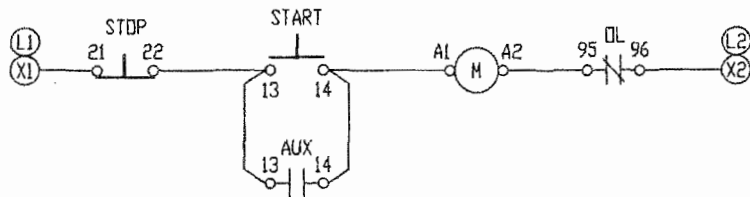
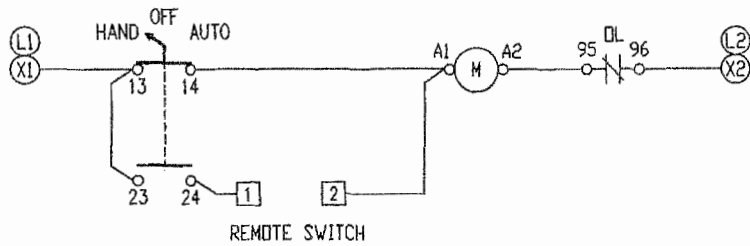

WARNING

HAZARDOUS VOLTAGE WILL CAUSE DEATH OR SERIOUS INJURY. TO AVOID ELECTRICAL SHOCK OR BURN TURN OFF MAIN AND CONTROL VOLTAGES BEFORE PERFORMING INSTALLATION OR MAINTENANCE

REV	DESCRIPTION	DATE	APP'D	DRAWN	LR	Description	
				CHECKED	TG	SINGLE PHASE STARTER LSK, EEC AND ECX Series	
				APPROVED			
				DATE			
				01/18/07			
							Electrical and Electronic Controls, Inc. 3981 Danbury Rd Brewster NY, 10509 USA (845)-278-5777 Fax (845)-278-5444 Email: info@eecontrols.com www.eecontrols.com
						Drawing No.	REV.
						SXLS	0