

LOW VOLTAGE - C.C.W.

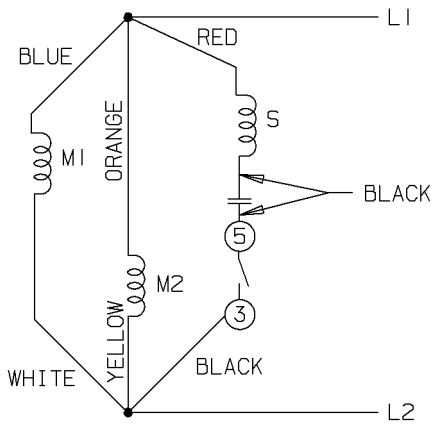

HIGH VOLTAGE - C.C.W.

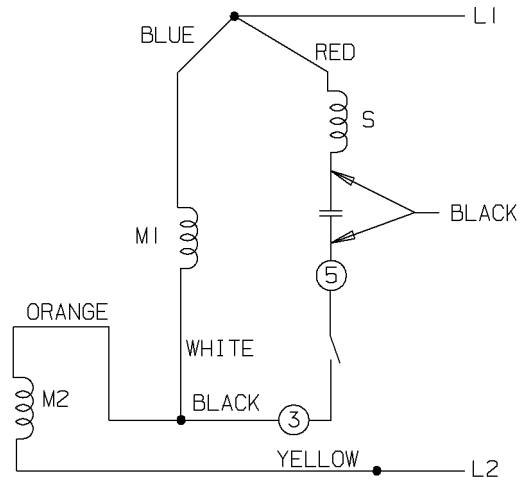

A-102005-51

DUAL VOLTAGE
CAPACITOR START NO
OVERLOAD SELECT ROTATION

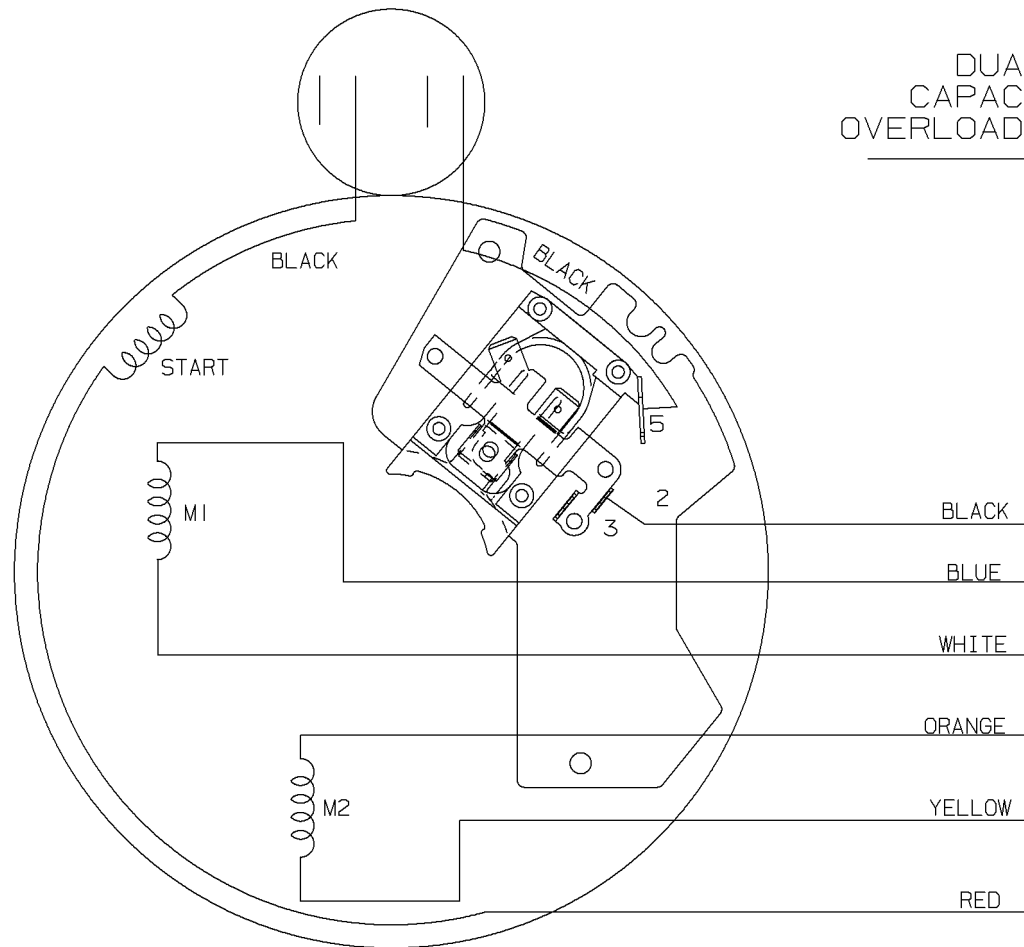

LOW VOLT. - C.C.W. ROT.

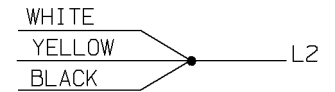
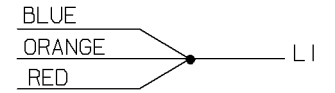

HIGH VOLT. - C.C.W. ROT.

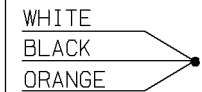
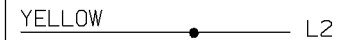
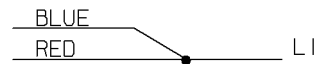

FOR C.W. ROTATION EITHER
VOLTAGE INTERCHANGE
RED WITH BLACK LEAD

				✓ MAX. SURFACE ROUGHNESS UNLESS NOTED OTHERWISE	UNLESS OTHERWISE SPECIFIED DIMENSIONS ARE IN INCHES TOL. ON XX± XXX±.005 XXXX±.0005 ANGLES±			
				MATL SPEC				DRAWN BY CAV 06-18-1999
				FINISH				CHKD BY ML 06-18-1999
5	06-17-1999	REDRAWN	CAV	REFERENCE DRW.	WAUSAU, WISCONSIN 54401			APPD BY GK 06-18-1999
REV	DATE	CHANGE	NAME	PART NAME CONNECTION DIAGRAM				DRWG NO A-102005-51

SHOP BOOK

PURCHASED

DISTRIBUTION - WA - LB - WP - LM - BR

CADD FILE NO.

102005-51

ERROR: syntaxerror
OFFENDING COMMAND: --nostringval--

STACK:

/p2e
-savelevel-